

RTC Series

Reference Temperature Calibrator

RTC-168

► **Sanitary Sensor Calibration**
High Speed, & High Volume Calibration



Your Sanitary Sensor Solution

One of the technicians' most challenging calibration jobs is the awkward sanitary sensors used predominately in the pharmaceutical and food and beverage industries. To accurately calibrate these sensors, the technician must place the sensing element in the uniform zone of the temperature calibrator. However, correctly placing the sensing element is often difficult due to the small length of the sanitary sensor or the large flange above the sensor.

At AMETEK STC, we have worked closely with our customers to understand these difficulties, and now we are pleased to offer a solution with our RTC-168 Reference Temperature Calibrator.

Building on the knowledge gained with two previous combination dry-block/wet bath temperature calibrators, we have added innovative, industry-first features and a new patent-pending calibration process. The longer uniformity zone in the sensor basket and the special sanitary insert perfectly support accurate calibration of sanitary sensors. The wider temperature range will open new possibilities that we previously couldn't support with our wet/dry calibrator.

We are confident that our RTC-168 temperature calibrator is the sanitary sensor calibration solution you have been waiting for in a portable calibrator, whether in dry-block or wet bath mode.



Key Features

- ▶ **New Liquid Calibration System:** A redesigned liquid calibration system and a faster magnetic stirrer result in a longer temperature uniformity zone. This vertically extended zone now makes it reachable for shorter sanitary sensor.
- ▶ **More Space to Support Large Flanges:** Will now support calibration of sanitary sensors with diameters up to 84 mm.
- ▶ **Removable Liquid Container:** The RTC-168 features a removable liquid insert/container, making switching from wet to dry easier, faster, and much cleaner. Remove the container with liquid, and it's a dry-block calibrator again... No cleaning needed!
- ▶ **Quick Portability:** The liquid container includes a screw-on lid with a built-in pressure relief valve. In the case of temperature or elevation change while transporting, the relief valve protects the user by releasing the increased pressure from the closed system.
- ▶ **Special Sanitary Sensor Dry-Block Insert:** For those customers who prefer to calibrate their sanitary sensors with a dry-block calibrator, we designed a special insert to accommodate short sensors. Adapters to different models are also available.
- ▶ **Unique Airflow System:** In an industry first, we have reversed the airflow system in the RTC-168, pushing the hot air out the bottom of the calibrator rather than the top. This protects the customer's sensors under test from the heated exhaust air.
- ▶ **New IP68 Interchangeable Reference Sensor:** Our new STS-102A-035 reference sensor matches the RTC-168 temperature range, but more importantly is compatible with both dry and wet applications. Use it as usual in a dry-block application, and then switch to liquid calibration applications without using a protection tube.
- ▶ **Save Time and Money With Fast Heating Time:** Total heating time from -22°C to 155°C is over twice as fast as previous JOFRA models.

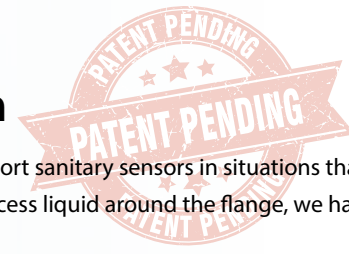

Sanitary Sensor Calibration in Our Temperature Bath

Our new patent-pending temperature calibration technique allows users to calibrate large diameter, short sanitary sensors in situations that closely mirror the sensor's day-to-day use. By isolating the liquid in the main block from the excess liquid around the flange, we have removed the liquid flow effect and the need for a precise liquid level, two traditional sources of error.

We have combined knowledge learned through our years of producing temperature calibrators with the feedback given by users in the field and created the industry's only portable temperature calibrator capable of high-accuracy wet calibrations of sanitary sensors up to 84 mm in diameter.

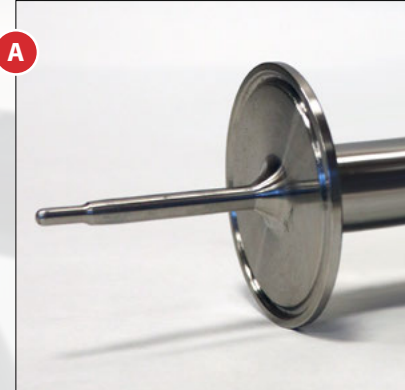
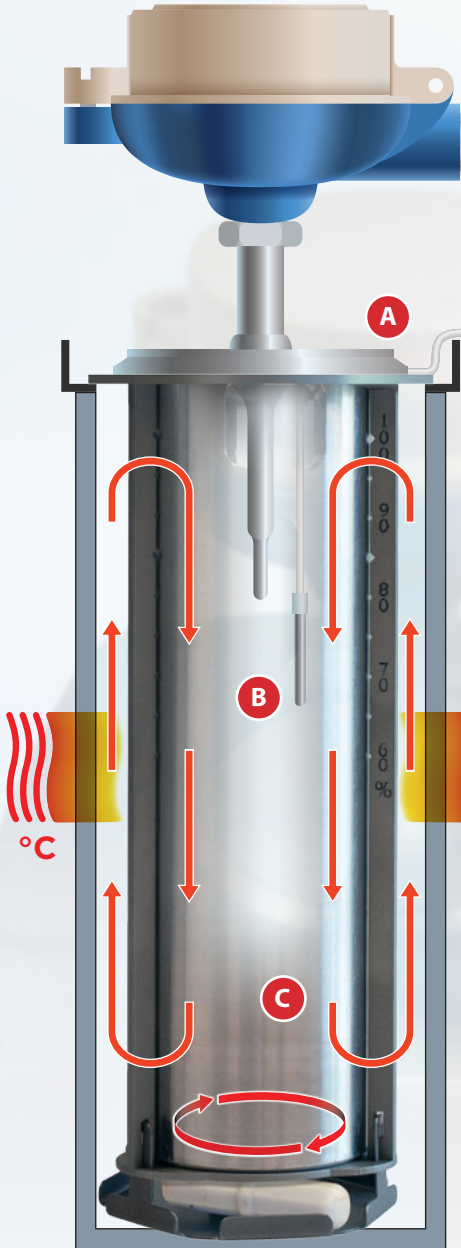

A newly designed, larger calibration surface allows the RTC-168 to accept sanitary sensors with diameters up to 84 mm in diameter.

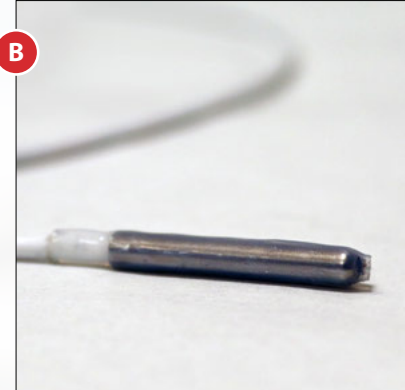

The new IP68 classified cable reference sensor (STS-102-A-035) fits under the sanitary sensor flange through a groove in the sensor basket.



The heat conveyor block isolates the liquid in the main block from the excess fluid around the flange.

The heat conveyor block transfers the heat from the calibrator to the sanitary sensor directly through the aluminum of the heat conveyor. This method creates a much more consistent heat transfer than the traditional method of transferring heat through the liquid.

Sanitary Sensor Calibration in the Dry-Block Configuration

For customers that prefer the speed and cleanliness of a dry-block calibrator, we offer solutions to help you calibrate sanitary sensors. It starts with a custom insert that includes a cable groove which allows users to slide our new STS-102 A 035 reference sensor under the flange of the sanitary sensor. Place the sanitary sensor into the middle of the insert, and you're ready to calibrate. As sanitary sensors and sensor tips are available in countless shapes and designs, we can design and produce special inserts and deliver a genuinely plug n' play sanitary sensor calibration system.

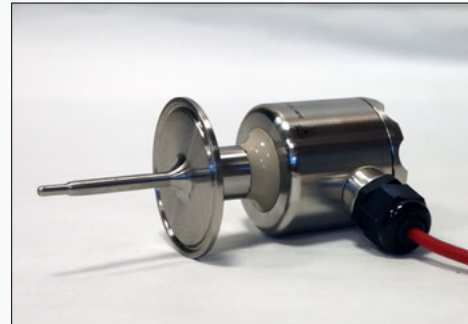

Once mounted, the RTC-168 combines the external cable reference sensor and the built-in internal reference sensor to fuel its dual-zone technology and proven Set Follows True function to ensure consistent temperature from the main zone through the upper calibration zone. As technicians can easily transport the RTC-168, they can now provide in-field calibration of difficult sanitary sensors.



Sanitary Sensor and Insert.



STS-102 A 035 sensor in an insert.



STS-102 A 035 sensor and sanitary sensor in an insert, mounted in an RTC-168 calibrator.

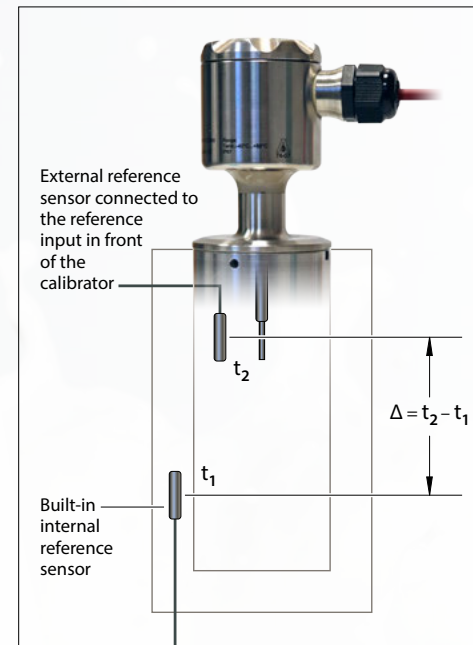

Set Follows True and dual-zone technology make dry sanitary sensor calibration possible.



Additional RTC-168 Dry-Block Features

Calibrating Large Sanitary Sensors

As sanitary sensors come in many shapes and sizes, the flange of the sensor can often create the biggest challenge for calibration technicians. If the diameter is too large, this may prevent the sensing element from reaching the ideal zone in the temperature calibrator.

The RTC-168 solves this problem with the largest upper surface opening found in any JOFRA calibrator. The increased space now accepts sensor flanges up to 84 mm (24 mm more than our previous model), allowing the sensing element of the sensor to reach the calibration zone easily.

In addition to the large upper surface, the RTC-168 includes a 160 mm (6.3") deep well with a diameter of 63.5 mm (2.5")—twice the size of any other dry-block. It is now possible to calibrate even more temperature sensors simultaneously and calibrate large and odd-shaped sensors inside the large well.

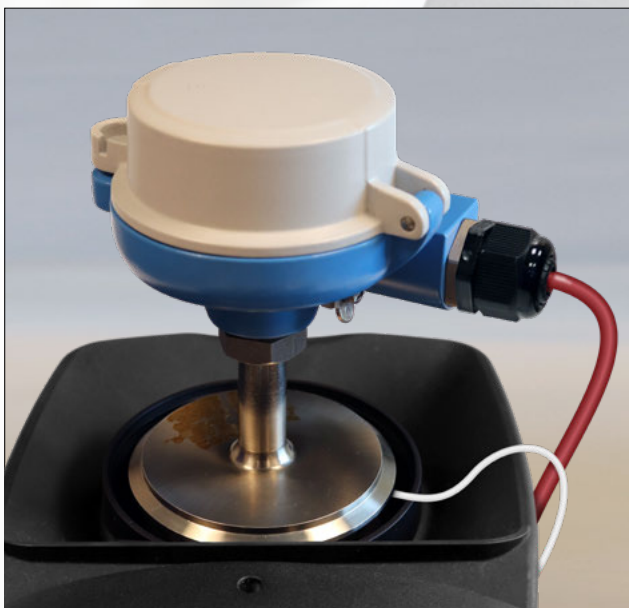

Assembled RTC-156 insert and RTC-158 adapter.

New Insert Adapter Supports Your Investment



RTC-156 insert with RTC-168 adapter.

For customers who are currently using our JOFRA ATC-156 & RTC-156 for their sanitary sensor calibrations, we have a solution that will save you money. Our new insert adapter allows you to slide your current ATC/RTC-156 insert into the adapter, and then place the insert/adapter combination directly into the RTC-168. This allows you to reuse your existing insert and avoid an additional cost.



Assembled RTC-156 insert and RTC-158 adapter.

Dry-Block and Liquid Temperature Bath Calibration

When considering their temperature calibration options, technicians often must decide between a dry-block calibrator and a liquid temperature bath. Each solution has distinct advantages over the other, and they also come with different drawbacks. But, with the RTC-168, you don't have to decide. You can have the best of both worlds. And if that wasn't enough, our new liquid container makes switching from one to the other quick, safe, and clean.

Advantages of Liquid Calibration

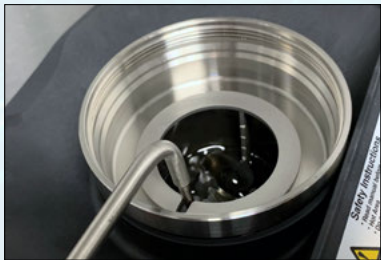

- You do not need inserts for the different types of sensors.
- You can calibrate sensors that wouldn't fit in an insert.
- You can calibrate glass thermometers and gas or liquid filled sensors.
- You can calibrate any type of odd shape sensor.

Advantages of Dry Calibration



- No hazardous or hot liquids.
- Easier to handle inserts rather than liquid.
- More convenient to carry a dry-block.
- No need for external exhaustion.
- 100% repeatability due to the fixed sensor position in the block.
- No oil contamination of the sensor under test.

Advantages of a Combined Liquid Bath/Dry Block Calibrator



- Can calibrate all sensors, whether they are long, short, odd-shaped, or flange mounted.
- Two calibrators in one.
- Full flexibility to choose between liquid and dry configurations as needed.
- Quickly switch between wet and dry to fit the application.

New Liquid Container

Although customers of our previous models enjoyed the flexibility of switching from dry-block to liquid bath modes, making this switch had its challenges, especially when switching from wet to dry. We listened to their feedback and created a new liquid container. Technicians can now pour their liquid into the container and place the container into the well. Once they complete their liquid test, simply remove the container from the well, and it's back to a dry-block. Or, if your lab uses multiple liquid types, keep a container for each type and switch back and forth as needed.

It's a safer, cleaner, and easier solution, adding to the flexibility of the RTC-168.

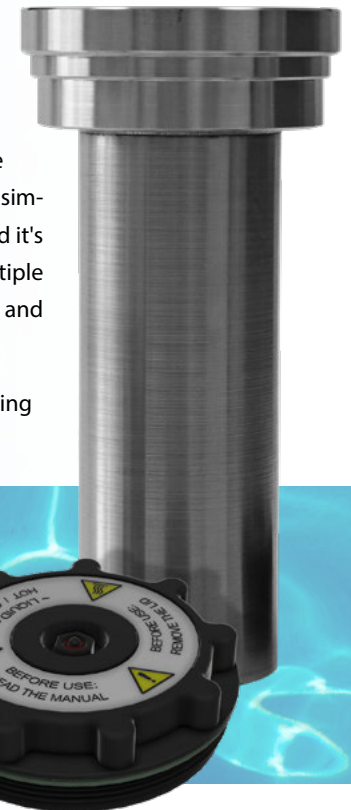

DLC—Dynamic Load Compensation. Making Dry Calibration Accurate and Well Documented

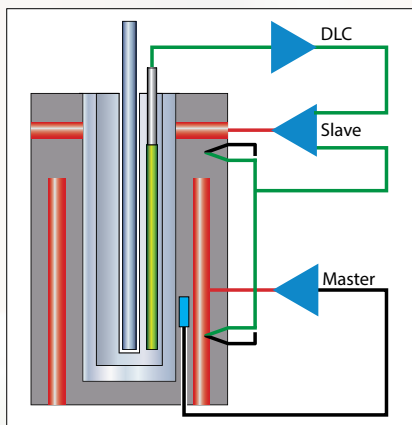

To bring our well documented active dual-zone technology to an even higher level, we have developed the patented DLC system.

This feature makes it possible to perform top calibration specifications without being affected by the actual load, e.g. many sensors or very big sensors.

The DLC sensor improves on the RTC calibrator's already advanced dual-zone technology by controlling the homogeneity in not only the well, but inside the insert where the sensors-under-test are placed during calibration. The DLC sensor measures the temperature homogeneity in the insert and provides feedback to the active dual-zone system, which compensates the temperature difference to a minimum inside the insert. In this way, the DLC function makes the homogeneity independent of the different loads of the insert, making the RTC the best performing dry-block calibrator on the market when calibrated and tested according to the globally accepted EURAMET/cg-13v.01 guideline for calibration and testing of dryblocks.

The DLC system is comprised of a special differential temperature sensor designed especially for the RTC. The sensor is placed in the insert and connected to the calibrator. When the DLC function is enabled, the calibrator will automatically equalize the temperature homogeneity inside the insert, along with the normal temperature control and stabilization. **Note that DLC functionality can not be used when calibrating sanitary sensors.**

DLC—User Advantages

Calibrating with the DLC sensor offers the following advantages:

- 1 Calibration of several sensors simultaneously.
- 2 Calibration of thick sensors.
- 3 Gives TSL (Thermo Sensitive Length) independency. It is no longer necessary to know the TLS of the sensor.
- 4 Compensates for sensor production tolerances like the PT100 element being mounted in various positions in the sensor.
- 5 Trouble free calibration of sensors with PT100 elements up to 60 mm length.
- 6 The DLC indicator proves that the dual-zone is active and functioning well.
- 7 Proves that the calibrator is working perfectly. The DLC value should be very close to 0.00 when the calibrator is loaded with DLC sensor and an external reference sensor.
- 8 Together with the stability indication, the DLC indicates when the calibration values can be read.
- 9 JOFRA's unique, patented DLC system allows RTC dryblock calibrators to perform with "close-to-laboratory" liquid bath performance.

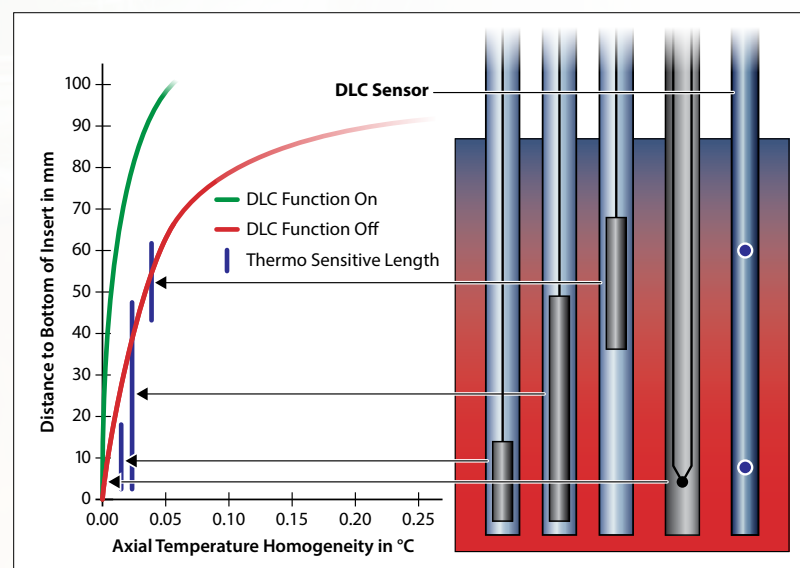

Axial temperature curves for an RTC calibrator with and without the DLC functionality activated.

High Accuracy Temperature Calibrator

Among the many features of the RTC Series, one of the most important that our customers depend on is its high accuracy. Through years of innovation and patents, we have continued to solve challenges our customers face when calibrating a wide variety of temperature sensors.

Homogeneous Zones

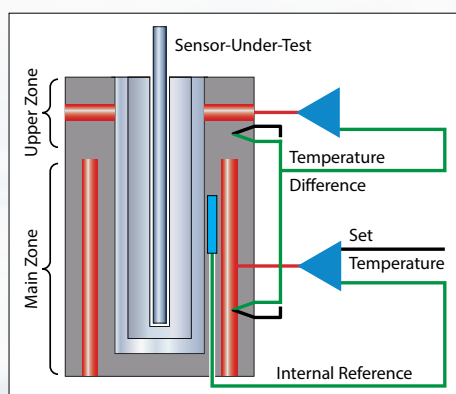

The RTC series of calibrators provide precision temperature calibration of sensors, whatever the type or format. Our innovative active dual-zone heating technology independently controls each heating zone. This control produces two homogeneous zones, increasing the chances that the sensing element of the sensor-under-test will reach one of these ideal calibration zones. The lower zone ensures optimum heat dissipation throughout the entire calibration zone, while the upper zone compensates for heat loss from the

sensor-under-test and the open top. This design also eliminates the need for extra insulation of sensors-under-test and makes it possible to calibrate liquid-filled and other mechanical sensors.

The sensor basket prevents sensors from interfering with the stirrer while also helping to create the largest possible temperature homogeneous zone. The sensor basket produces virtually zero axial and radial gradients in the calibration zone.

Liquid Bath Kits



Liquid Bath Kit 1

- Sensor Basket with Temperature Equalizer Tube and Bottom Shield.
- Lid with Safety Valve.
- Covering/Insulation Plug.
- Stirring Magnet (qty 3.)
- Liquid Drainage Tube.
- 0.75 liters of silicone oil 10.



Liquid Bath Kit 2

- Everything Included in Kit 1.
- Liquid Container.

Reference Sensors

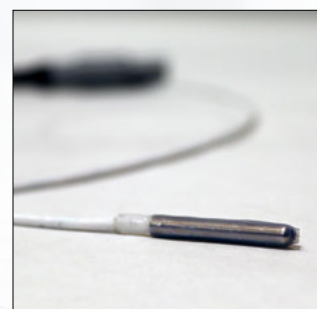

We offer reference sensors that communicate directly with the RTC to automate accurate calibrations for customers looking to provide an even more accurate system.

Our patented DLC system (when used in the dry-block configuration) takes the dual-zone heating technology a step further by controlling the homogeneity inside the insert where the sensors-under-test are. The result is a high accuracy calibration, no matter what size or how many sensors are in the insert.

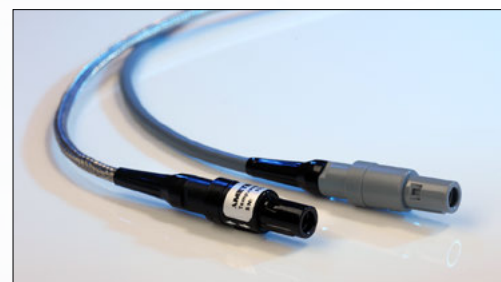

In addition to the DLC, all JOFRA intelligent reference sensors contain the calibration data inside the sensor. Using these sensors removes a source of error as the technician avoids manually entering calibration details. Special 90° sensors and cable-type sensors provide even more flexibility for unique calibration jobs.

Important RTC Features

While the RTC Series boasts several features designed to bring the highest accuracy, we also have strived to make it easy to use. A simple user interface and helpful features are what help the RTC stand apart from the competition.

User Interface

The RTC features a full-color display, which shows all vital information for the current set-up in large, easy-to-read digits. In addition to the temperature information for the current set-up, users can quickly see the stability status, load compensation status, the reference serial number, and the sensor under test's status. Clear, intuitive menus provide additional set-up information, and the interface is available in English, German, Chinese, and Japanese. Some special user interface features include:

- ▶ **Intelligent Recalibration Information:** The RTC includes an automatic check on its calibration date, along with the dates of any connected STS or DLC sensors. If any of these calibration periods have expired, the unit displays a warning during start-up.
- ▶ **Set-Follows-True:** This automatic feature adjusts the RTC temperature until the reference sensor (true) meets the desired set temperature (set). This feature helps assure that the temperature in the calibration zone matches the desired set point. Once this occurs, an indication alerts the technician that it's time to collect a reading. This feature is especially useful in auto-stepping mode.
- ▶ **Switch Test:** Users may perform a thermostatic test and find "Open," "Closed," and the hysteresis (deadband) automatically. The instrument retains the last twenty test results.
- ▶ **Auto-Stepping:** Users can program up to 20 different temperature steps, including the hold time for each step. After pressing start, the RTC will complete the routine automatically. Upon completion, the user can easily read the results on the RTC display.
- ▶ **Customizable Stability Indicator:** Technicians can set the stability criteria for external reference sensors and sensors under tests. The RTC will display the stability checkmark once the criteria is met, which is the indicator for the technician to take the reading.

- ▶ **Stored Set-Ups:** For users who routinely reuse the same instrument set-ups, they can store the setting in their RTC, so they can quickly retrieve them the next time.
- ▶ **Temperature Limits:** Users can set the maximum and minimum temperature for a particular sensor through the set-up menu. These limits will protect the sensor if the user makes a mistake and attempts to subject it to a temperature outside its boundaries.

Performance

The RTC series includes performance features designed to enhance the overall usability of the calibrator. We understand the investment required to purchase a high-end temperature calibrator, so we created a product to help companies maximize their investment.

- ▶ **Fast Temperature Calibration:** Compared to the RTC-158, the heating speed is improved by 175%, and cooling speed is improved by 15%. The results are savings in both production downtime and general calibration costs.
- ▶ **MVI-Secure Temperature Stability:** MVI stands for "Mains power Variance Immunity". Unstable mains power (from other production equipment cycling power off and on) contributes to on-site calibration inaccuracies. The RTC series employ functionality to avoid these stability issues.
- ▶ **Reading of Sensor-Under-Test (B Model):** The RTC Series automatically reads virtually any temperature sensor, including RTD, TC, transmitters, mA, V, and thermostats. This feature allows for automatic temperature calibration.
- ▶ **Silent Operation:** When using the calibrator in a shared space, the technician can run in silent mode to reduce calibrator noise.

Accessories and Supporting Products

We have a line of accessories and supporting products that further enhance the RTC-168 temperature calibrator. These products provide options to pick and choose from depending on your application requirements. We have something to support almost any situation, from items that make calibrating and transporting easier to products that change and document the calibration process.

Important Accessories



Specialty Designed Carrying Case

It's more than just a rolling case. Our case includes compartments to store the STS and DLC sensors, the liquid container, inserts, insulation plugs, the support rod set, and tools. Perfect for your portable calibrator.



Multi-Hole Inserts

We offer two multi-hole inserts to fit almost any sensor diameter without buying numerous inserts. One for metric and one for imperial, our inserts include many sizes and room for reference and DLC sensors.

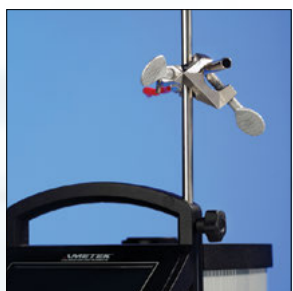

Integrated Support Rod

The integrated support rod helps to mount sensors under test. It is lightweight and mounts on two fixing holes integrated into the RTC calibrator.

Supporting Products

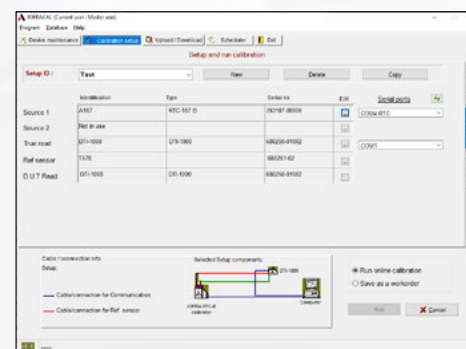

JofraCal Calibration Software

JofraCal is a highly versatile calibration software included with the RTC calibrators. The software communicates with the RTC to help ensure easy calibration of all kinds of temperature sensors, such as RTD's, thermocouples, transmitters, and thermostats.

JofraCal has a manual set-up that accepts user-entered data or an automatic mode that allows the RTC to operate as a stand-alone instrument with work orders. The software stores all completed calibration information on the computer for easy retrieval and printing.

For more information and details, [visit our JofraCal website here.](#)



JOFRA ASM Scanner

Using the JOFRA RTC series together with the ASM, Advanced Signal Multi-scanner, offers a great time-saving automatic solution to calibrate multiple temperature sensors at the same time. The ASM series is an eight-channel scanner controlled by the JofraCal software on a PC. Up to 3 ASM units can be stacked to calibrate up to 24 sensors at a time. It can handle signals from 2-, 3- and 4 wire RTD's, thermocouples, transmitters, temperature switches, and voltage.

Specifications

Functional Specifications

Temperature Range

Dry and Liquid

@ ambient temp. 0°C/32°F..... **-30 to 165°C/-22 to 329°F**

@ ambient temp. 23°C/73°F..... **-30 to 165°C/-22 to 329°F**

@ ambient temp. 40°C/104°F..... **-17 to 165°C/1.4 to 329°F**

Liquid in Container

@ ambient temp. 0°C/32°F..... **-30 to 160°C/-22 to 320°F**

@ ambient temp. 23°C/73°F..... **-26 to 160°C/-15 to 320°F**

@ ambient temp. 40°C/104°F..... **-13 to 160°C/8.6 to 320°F**

Accuracy with External STS Ref. Sensor (models B and C)

In Insert..... **±0.045°C/±0.081°F**

In Bath..... **±0.045°C/±0.081°F**

In Bath in Container..... **±0.045°C/±0.081°F**

12-month period. Relative to reference standard. Specifications by use of the external JOFRA STS-200 reference sensor.

Accuracy with Internal Ref. Sensor (models A, B, and C)

In Insert; Calibrated with Insert..... **±0.18°C/±0.32°F**

In Bath; Calibrated with Insert..... **±0.21°C/±0.38°F**

In Bath; Calibrated in Bath..... **±0.14°C/±0.25°F**

Stability

Block, Bath, Bath in Container..... **±0.01°C/±0.018°F**

Measured after the stability indicator has been on for 15 minutes.

Measuring time is 30 minutes

Resolution (user selectable)

All Temperatures..... **1° or 0.1° or 0.01° or 0.001°**

Temperature Unit in Display

User Selectable..... **°C, °F, or K**

Radial Homogeneity (difference between holes)

@ -30°C/-22°F, Block..... **0.02°C/0.04°F**

@ 165°C/329°F, Block..... **0.03°C/0.06°F**

@ -20 to 165°C/-4 to 329°F, Bath..... **0.015°C/0.03°F**

@ -30 to -20°C/-22 to -4°F, Bath..... **0.029°C/0.05°F**

Heating Time

-30 to -23°C/-20 to 73°F..... **4 minutes**

23 to 100°C/73 to 212°F..... **9 minutes**

100 to 165°C/212 to 329°F..... **11 minutes**

Cooling Time

165 to 100°C/329 to 212°F..... **12 minutes**

100 to 23°C/212 to 73°F..... **22 minutes**

23 to 0°C/73 to 32°F..... **13 minutes**

0 to -15°C/32 to 5°F..... **17 minutes**

-15 to -30°C/5 to -22°F..... **42 minutes**

Time to Stability (approx.)

Block..... **30 minutes**

Bath..... **15 minutes**

Bath in Container..... **30 minutes**

Immersion Depth

Including insulation plug..... **180 mm/7.1 in**

Bath version..... **150 mm/5.9 in**

Physical Specifications

Weight and Instrument Size (LxWxH)

Weight..... **10.9 kg/24.0 lb**

(LxWxH)..... **366 x 171 x 363 mm/14.4 x 6.7 x 14.3 in**

Shipping (without carrying case)

Weight..... **17 kg/37.5 lb**

(LxWxH)..... **580 x 250 x 500 mm/22.8 x 9.8 x 19.7 in**

Shipping (including optional carrying case)

Weight..... **28 kg/61.7 lb**

(LxWxH)..... **550 x 430 x 660 mm/21.7 x 16.9 x 26.0 in**

Input Specifications

All input specifications apply to the dry-block of the calibrator running at the respective temperature (stable plus an additional 20 minute period).

All input specifications are valid for the RTC-168.

RTD Reference Input (models B and C)

Type..... **4-wire RTD with true ohm measurements (1)**

F.S. (Full Scale)..... **400 ohm**

Accuracy (12 months)..... **±(0.0012% rdg. + 0.0005% F.S.)**

RTD Type	Temperature		12 Months	
	°C	°F	°C	°F
Pt100 Reference	-30	-22	± 0.008	± 0.014
	0	32	± 0.008	± 0.015
	28	82	± 0.009	± 0.016
	165	329	± 0.011	± 0.019

(1) True ohm measurement is an effective method to eliminate errors from induced thermoelectrical voltage.

DLC Sensor Input (models B and C)

TC diff	Temperature		12 Months	
	°C	°F	°C	°F
DLC 168	-30	-22	± 0.011	± 0.020
	0	32	± 0.010	± 0.018
	28	82	± 0.010	± 0.018
	165	329	± 0.008	± 0.015

At 0.00°C/0.00°F DLC reading.

Specifications

RTD Sensor Under Test Input (model B)

F.S. (range) **400 ohm**
 Accuracy (12 months)..... **±(0.002% Rdg.+0.002% F.S)**
 F.S. (range)..... **4000 ohm**
 Accuracy (12 months)..... **±(0.005% Rdg. + 0.005% F.S.)**
 2-wire..... **add 50 mOhm**

RTD Type	Temperature		12 Months	
	°C	°F	°C	°F
Pt100	-30	-22	± 0.025	± 0.044
	0	32	± 0.026	± 0.047
	28	82	± 0.026	± 0.047
	155	311	± 0.030	± 0.054
	250	482	± 0.033	± 0.060
Pt500	-30	-22	± 0.111	± 0.200
	0	32	± 0.116	± 0.209
	28	82	± 0.118	± 0.212
	155	311	± 0.129	± 0.232
	250	482	± 0.131	± 0.236
Pt1000	-30	-22	± 0.061	± 0.109
	0	32	± 0.064	± 0.115
	28	82	± 0.066	± 0.119
	155	311	± 0.075	± 0.135
	250	482	± 0.082	± 0.148

Input and curves for many different resistance sensors such as:
 0-400Ω
 P10(90)386/P50(90)385/P100(90)385/P50(90)391/P100(90)391/
 P100(90)392/M50(90)428/M100(90)428/H120(90)672Pt-100 MILL
 0-4000Ω
 P200(90)385/P500(90)385/P1000(90)385/YSI-400

Thermocouple Input

Range **± 78 mV**
 F.S. (Full Scale)..... **78 mV**
 Accuracy (12 months) **±(0.005% Rdg. + 0.005% F.S.)**

TC Type	Temperature		12 Months*	
	°C	°F	°C	°F
E	-50	-58	± 0.09	± 0.17
	0	32	± 0.06	± 0.11
	155	311	± 0.06	± 0.11
J	-50	-58	± 0.10	± 0.18
	0	32	± 0.08	± 0.14
	155	311	± 0.09	± 0.16
K	-50	-58	± 0.14	± 0.24
	0	32	± 0.10	± 0.19
	155	311	± 0.11	± 0.20
T	-50	-58	± 0.15	± 0.26
	0	32	± 0.10	± 0.18
	155	311	± 0.08	± 0.15
R	-50	-58	± 1.30	± 2.35
	0	32	± 0.78	± 1.40
	155	311	± 0.47	± 0.84
S	-50	-58	± 0.98	± 1.76
	0	32	± 0.78	± 1.40
	155	311	± 0.49	± 0.89
N	-50	-58	± 0.20	± 0.35
	0	32	± 0.15	± 0.27
	155	311	± 0.13	± 0.23
U	-50	-58	± 0.13	± 0.24
	0	32	± 0.10	± 0.18
	155	311	± 0.08	± 0.14
	320	608	± 0.08	± 0.15

* Excludes CJC accuracy ± 0.3° C / ± 0.54° F.

Transmitter Supply

Output Voltage **24VDC ±10%**
 Output Current **Maximum 28 mA**

Transmitter Input mA (model B)

Range **0 to 24 mA**
 Accuracy (12 months)..... **±(0.005% Rdg. +0.010% F.S.)**

Voltage Input VDC (model B)

Range **0 to 12 VDC**
 Accuracy (12 months)..... **±(0.005% Rdg. +0.010% F.S.)**

Switch Input (model B)

Switch Dry Contacts

Test Voltage..... **Maximum 5 VDC**
 Test Current..... **Maximum 2.5 mA**

Mains Specifications

Voltage **115V (90-127) / 230V (180-254)**
 Frequency, non US Deliveries **50/60 Hz (47-63 Hz)**
 Frequency, US Deliveries **60 Hz (57-63 Hz)**
 Power Consumption (max.) **500 VA**

Communications Interface

Serial Data Interface..... **USB 2.0 Device Port**
 Serial Data Interface..... **USB 2.0 host Double Port***
 LAN..... **Ethernet MAC 10/100 Base-T***
 SD..... **SD slot***

* For future expansion.

Miscellaneous

Operating Ambient Temperature..... **0 to 40°C / 32 to 104°F**
 Storage Temperature..... **-20 to 50°C / -4 to 122°F**
 Humidity **0 to 90% RH**
 Protection Class..... **IP-10**

Specifications

Inserts

All inserts are supplied with a matching insulation plug, except for custom designed Sanitary Sensor inserts.

Insert Dimensions (Standard Insert)

Outer Diameter **63.5 mm / 2.5 in**
Length **160 mm / 6.3 in**

Insert Dimensions (Extended Sanitary Sensor Insert)

Outer Diameter **63.5 mm / 2.5 in**
Length **173 mm / 6.81 in**

Weight of Non-Drilled Insert (approx.)

Standard Insert **1200 g / 42.3 oz**
Extended Sanitary Sensor Insert **1300 g / 45.9 oz**

Alloy

Special Aluminum Alloy

Use of other inserts may reduce the performance of the calibrator. To get the best results out of the calibrator, the insert dimensions, tolerance, and material is critical. We highly advise using JOFRA inserts, as they guarantee trouble-free operation.

Undrilled Inserts

(Ø 63.5 mm; 160 mm length)

Inserts	Instrument	
	Insert Code*	RTC-168
Undrilled Insert	UN1	130489
Undrilled Insert with DLC	UN2	130488
Undrilled Insert with DLC and reference sensor 4 mm and 1/4 in	UN3	130486

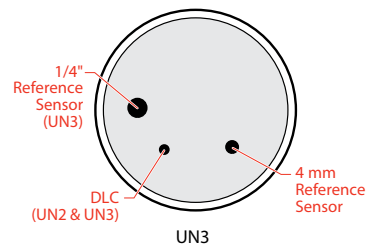

Metric (mm) Multi-hole Insert (Ø 63.5 mm; 160 mm length)

Inserts	Instrument	
	Insert Code*	RTC-168
Metric Multi-Hole Insert	M01	130490

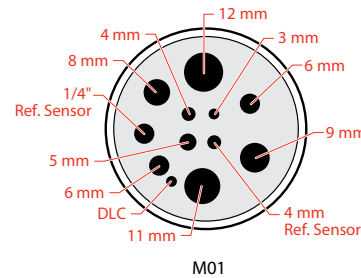

Imperial (in) Multi-hole Insert (Ø 63.5 mm; 160 mm length)

Inserts	Instrument	
	Insert Code*	RTC-168
Imperial Multi-Hole Insert	M02	130491

* Use the insert code, when ordering a JOFRA standard undrilled insert together with the RTC calibrator.

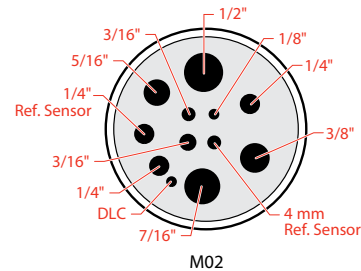

Custom Designed Inserts (Ø 63.5 mm; 160 mm length)

Inserts	Cat. No.
Single-Hole (SUT + DLC + Reference Holes)	130493
Multi-Hole (Max. 7 holes + DLC hole)	130494
Multi-Hole (Max 7 SUT holes)	130495

Custom inserts are supplied with a matching plug. Fill in insert scheme 105171 upon order.

Extended Inserts for Sanitary Sensors (Ø 63.5 mm; 173 mm length)

Inserts	Cat. No.
Undrilled Insert with Cable Groove for STS102 Cable for Sanitary Sensor Calibration	130263
Custom Insert with Cable Groove for STS102 Cable and Drilled Hole for Sanitary Sensor Calibration	130506
Adapter for ATC/RTC-156 Sanitary Sensor Insert for Dry Calibration of Sanitary Sensors	130196
Undrilled Sanitary Sensor Insert RTC-156	123824
Custom Insert RTC-156 Sanitary Sensor Insert Drilled According to Customer Supplied Drawing	123868

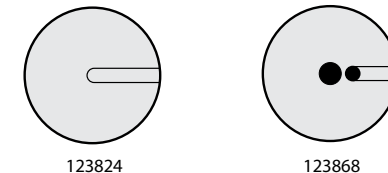
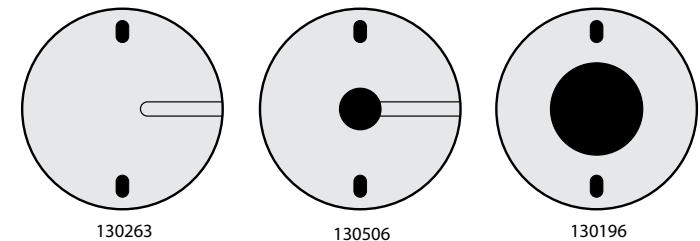

Options & Accessories

Standard Delivery

Models A, B, and C Include:

- RTC dry-block calibrator (user specified)
- Mains power cable (user specified)
- Traceable certificate - temperature performance
- Tool for insertion tubes
- JOFRACAL
- AMETRIM
- USB cable
- Set of rubber cones for insulation plugs
- Manual

Model B Instruments Also Include:

- Test cables (2 x red, 2 x black)
- Traceable certificate - input performance for reference sensor and DLC sensor
- Traceable certificate - input performance for sensor-under-test inputs

Model C Instruments Also Include:

- Traceable certificate - input performance for reference sensor and DLC sensor

Accessories

Support Rod Set for Sensors (2 grips, 2 fixtures).....	127277
Extra fixture for sensor grip.....	125066
Extra sensor grip.....	125067
Mini-Jack connector for stable relay output	122771
Thermocouple Male Plug – Type J – Black.....	120516
Thermocouple Male Plug – Type K – Yellow.....	120517
Thermocouple Male Plug – Type N – Orange.....	120514
Thermocouple Male Plug – Type T – Blue	120515
Thermocouple Male Plug – Type R / S – Green	120518
Thermocouple Male Plug – Type Cu-Cu – White	120519
Silicone Oil, Type 200/5cST, 0.75 L, RTC-168.....	130509
Silicone Oil, Type 200/10cST, 0.75 L, RTC-158/168.....	125033
Silicone Oil, Type 200/50cST, 0.75 L, RTC-250.....	124885
Liquid Bath Kit, RTC-168.....	130403
Carrying Case with Trolley.....	127782
Liquid Container with Lid	130507

Functional Comparison



Model A
RTC-A reference temperature calibrator.



Model B
RTC-B reference temperature calibrator with input for reference sensor, DLC sensor, and sensors-under-test.



Model C
RTC-C reference temperature calibrator with input for reference sensor and DLC sensor.



Models	Model A	Model B	Model C
Dual-zone heating/cooling block	■	■	■
MVI – Mains Variance Immunity (or similar)	■	■	■
Stability indicator	■	■	■
Automatic step function	■	■	■
USB communication	■	■	■
Display resolution 0.001°	■	■	■
Programmable max. temperature	■	■	■
SYNC output (for external recording device)	■	■	■
Calibration of short sensors in special insert		■	■
External precision reference sensor input		■	■
External precision DLC reference sensor input		■	■
“SET” follows “TRUE”		■	■
Load compensation functionality		■	■
Input for RTD, TC, V, mA		■	
4-20 mA transmitter input incl. 24 VDC supply		■	
All inputs scalable to temperature		■	
Automatic switch test (open, close, and hysteresis)		■	
Download of calibration work orders from PC		■	
Upload of calibration results (as found & as left)		■	

Ordering Information

Base Model Number	
RTC168	RTC-168 series, -30 to 165°C (-22 to 329°F)
Model Version	
A	Basic model, without input
B	Full model, incl. DLC sensor input, Reference sensor input, Sensor-under-test input
C	Middle model, incl. DLC sensor input, Reference sensor input
Power Supply (US deliveries 60 Hz only)	
115	115 VAC
230	230 VAC
Mains Power Cable	
A	European, 230 V
B	USA/Canada, 115 V
C	UK, 240 V
D	South Africa, 220 V
E	Italy, 220 V
F	Australia, 240 V
G	Denmark, 230 V
H	Switzerland, 220 V
I	Israel, 230 V
Insert Type and Size	
NON	No insert selected (standard)
UNX	1 x Undrilled Insert (Please see Insert selection for code)
MXX	1 x Multi hole insert (Please see Insert selection for code)
L1	Liquid Type Kit 1 – Liquid Kit for RTC-168
L2	Liquid Type Kit 2 – Complete Container & Liquid Kit for RTC-168
Dynamic Load Compensation (B and C models only – optional)	
DLC	DLC sensor
STS Reference Sensor (B and C models only – optional)	
R26	STS-102A-035 Ref. sensor. Dia. 4 mm. Length 35 mm (STS102A035EH) for RTC-168
R24	STS-200 Ref. sensor. Dia. 4 mm. Length 201 mm (STS200A919EH) for RTC-168
R25	STS-200 Ref. sensor. Dia. 1/4". Length 201 mm (STS200B919EH) for RTC-168
Calibration Certificate	
F	Traceable Certificate to International Standards (standard delivery)
H	Accredited Certificate – ISO17025
HL	Accredited Certificate – ISO17025 – In Liquid
EA	Full EURAMET Accredited Certificate – ISO17025
HS	System Calibration – Accredited Certificate – ISO17025 (B & C model only)
HSL	System Calibration – Accredited Certificate – ISO17025 (B&C model only) – In Liquid
HSCL	System Calibration – Accredited Certificate – ISO17025 (B&C model only) – In Container Liquid
EAS	System Calibration – Full EURAMET Accredited Certificate – ISO17025 (B & C model only)
EASD	System Calibration – Full EURAMET Accredited Certificate with DLC – ISO17025 (B & C model only)
Base Model Number	
CT ..	Solid Protective Carrying case with trolley
SR ..	Support rod set
TR ..	Solid Protective Carrying case with trolley & Support rod set

RTC168 B 230 A MXX DLC R26 EA CT

Sample Order Number

RTC168B230AMXXDLR26EACT

JOFRA RTC-168 B with 230VAC, EU power cord, 1 multi-hole inert, DLC, 4 mm diameter STS-200 reference sensor, full EA temperature calibration certificate, and carrying case with trolley.

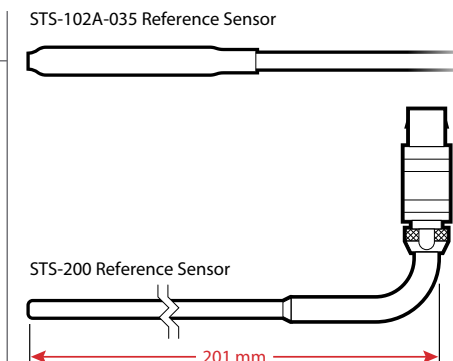

USA, Florida
Tel +1 (800) 527 9999
cal.info@ametek.com

USA, California*
Tel +1 (800) 444 1850
crystal@ametek.com

India
Tel +91 22 2836 4750
jofra@ametek.com

Singapore
Tel +65 6484 2388
jofra@ametek.com

China, Shanghai
Tel +86 21 5868 5111
jofra.sales@ametek.com.cn

China, Beijing
Tel +86 10 8526 2111
jofra.sales@ametek.com.cn

United Kingdom
Tel +44 (0) 1243 833 302
caluk.sales@ametek.com

France
Tel +33 (0) 30 68 89 40
general.lloyd-instruments@ametek.fr

Germany
Tel +49 (0) 2159 9136 510
info.mct-de@ametek.de

Denmark*
Tel +45 4816 8000
jofra@ametek.com

* ISO 17025 accredited calibration lab.

ametekcalibration.com

JOFRA[®] **calibration** 

No part of this document may be reproduced or modified in any form or by any means, electronic or mechanical, without express written permission from Crystal Engineering Corporation.